

Dell DX Object Storage  
Platform

**User's Guide**



# Notes, Cautions, and Warnings



**NOTE:** A NOTE indicates important information that helps you make better use of your computer.



**CAUTION:** A CAUTION indicates potential damage to hardware or loss of data if instructions are not followed.



**WARNING:** A WARNING indicates a potential for property damage, personal injury, or death.

---

**Information in this publication is subject to change without notice.**

© 2010–2011 Dell Inc. All rights reserved.

Reproduction of these materials in any manner whatsoever without the written permission of Dell Inc. is strictly forbidden.

Trademarks used in this text: Dell™, the DELL logo, PowerEdge™, and OpenManage™ are trademarks of Dell Inc. Red Hat® and Red Hat Enterprise Linux® are registered trademarks of Red Hat, Inc. in the United States and/or other countries.

Other trademarks and trade names may be used in this publication to refer to either the entities claiming the marks and names or their products. Dell Inc. disclaims any proprietary interest in trademarks and trade names other than its own.

# Contents

1	Introduction . . . . .	7
2	DX Object Storage Platform Overview . . . . .	9
	<b>Network Topologies</b> . . . . .	<b>9</b>
	Local Cluster Configuration . . . . .	10
	Subcluster Configuration . . . . .	14
	Remote Cluster Configuration . . . . .	16
	DX Cluster File Server Configuration . . . . .	18
	<b>Application Access to DX Object Storage Platform</b> . . . . .	<b>18</b>
	Communicating Directly With a Local Cluster . . . . .	18
	Communicating Directly With a Remote Cluster . . . . .	19
	Communicating With a Cluster Through the Cluster File Server . . . . .	19
3	Setting Up the DX Object Storage Platform . . . . .	21
	<b>Installing the Initial Cluster or Redundant Cluster Services Node</b> . . . . .	<b>21</b>
	<b>Configuring the DX Object Storage Platform</b> . . . . .	<b>21</b>
	<b>DX Content Router Rules Configurator</b> . . . . .	<b>22</b>

Using the Dell DX Content Router Rules Configurator . . . . .	23
Troubleshooting the Dell DX Content Router Rules Configurator (CRRC) . . . . .	25
<b>Adding Additional DX Storage Nodes . . . . .</b>	<b>26</b>
Installing the System in a Rack . . . . .	26
Cabling the Appliance . . . . .	26
Turning On the DX Storage Node . . . . .	26
Enabling Capacity in DX Cluster Services Console . . . . .	27
Adding Network Adapter to DX Storage Nodes . . . . .	27
Adding Network Adapters to DX Cluster Services Nodes . . . . .	27
Adding Cluster File Server Nodes . . . . .	28
<b>4 Updating the Dell DX Object Storage Platform Software . . . . .</b>	<b>31</b>
<b>Checking Software Version Compatibility . . . . .</b>	<b>32</b>
Using the DX Object Storage Platform Compatibility Manager . . . . .	32
Troubleshooting the Compatibility Manager . . . . .	33
<b>Updating the DX Cluster Services Node Software . . . . .</b>	<b>34</b>
<b>Updating the DX Storage Node Software . . . . .</b>	<b>34</b>
Receiving System Software Update Notifications . . . . .	35
Updating OpenManage Server Administrator . . . . .	35
<b>Updating the DX Cluster File Server Software . . . . .</b>	<b>36</b>

<b>5</b>	<b>Disaster Recovery</b>	<b>37</b>
	<b>Recovery Solution Map</b>	<b>37</b>
	<b>Recovering From Disk Failures</b>	<b>39</b>
	Single Disk Failure	39
	Two Disk Failure	39
	<b>Detecting and Monitoring Disk Failures</b>	<b>39</b>
	<b>Reinstalling the Operating System</b>	<b>40</b>
	<b>Configuring and Managing RAID</b>	<b>40</b>
	<b>Recovering the Operating System</b>	<b>41</b>
	<b>Configuring the Partitions During Operating System Recovery</b>	<b>41</b>
	<b>Reinstalling the DX Cluster Services Node Software</b>	<b>43</b>
	Setting Up and Configuring the Network	43
	<b>Connecting the DX Cluster Services Node to the Private and Public Networks</b>	<b>44</b>
	<b>Connecting the DX Storage Nodes to the Private Network</b>	<b>44</b>
	<b>Creating a Local YUM Repository on the DX6000 System</b>	<b>44</b>
	<b>Installing Dell DX Compatibility Manager</b>	<b>46</b>
	<b>Installing Dell DX Content Router Rules Configurator</b>	<b>46</b>
	<b>Installing Dell OpenManage Server Administrator</b>	<b>46</b>
	<b>Installing DX Cluster Services Node Software</b>	<b>47</b>

<b>Configuring the DX Cluster Services</b>	
<b>Node Software . . . . .</b>	<b>48</b>
<b>Restoring the Cluster Configurations . . . . .</b>	<b>48</b>
<b>Bringing Up the DX Storage Cluster . . . . .</b>	<b>48</b>
<b>6 Additional References . . . . .</b>	<b>49</b>
<b>Software Documents . . . . .</b>	<b>49</b>
<b>Hardware Documents . . . . .</b>	<b>51</b>
<b>Systems Management Documents . . . . .</b>	<b>52</b>

# Introduction

The Dell DX Object Storage Platform provides a simple and cost effective pool of storage for less active or fixed content. The object storage platform allows you to:

- Expand the capacity to meet rapidly changing needs without disrupting services.
- Set policies for file retention and replication.
- Distribute information to multiple geographic locations.
- Integrate through an HTTP based interface.
- Integrate through a CIFS/NFS Gateway.

The DX Object Storage Platform includes the following hardware and software:

- Dell DX6a00 Cluster Services Node (where *a* is a variable that indicates generation).
- Two or more Dell DX6axyS Object Storage Nodes (where *a* is a variable that indicates generation, and the variables *xy* indicate the number of drives. For example, 6012S indicates a 12-drive storage node).
- Dell DX6a00G Cluster File Server (optional) (where *a* is a variable that indicates generation and "G" indicates a general support node).
- A preinstalled operating system and Dell OpenManage software on the DX Cluster Services Node.
- Dell DX Object Storage Platform software.
- A pre-installed operating system on the DX Cluster File Server.
- Dell DX Cluster File Server software.

Table 1-1 lists the terms used in this document to refer to various components of the DX Object Storage Platform.

**Table 1-1. Terms Used in the Document**

<b>Component</b>	<b>Description</b>
DX Object Storage Cluster	DX6a00S system and two or more DX6axyS systems
DX Cluster Services Node, Cluster Services Node (CSN)	DX6a00 system
DX Object Storage Node, DX Storage Node (SN)	DX6axyS system
DX Content Router	Software component on the DX6a00 system
DX Object Storage Software	Software component on the DX6axyS system
DX Storage Cluster File Server, DX Cluster File Server (CFS)	DX6a00G system running DX Cluster File Server Software
DX Storage Compression Node (SCN)	DX6a00G system running DX Storage Compression Node Software



# DX Object Storage Platform Overview

## Network Topologies

The Dell DX Object Storage Platform network consists of one or more DX Storage Clusters connected by DX Content Router services. There are many possible network topologies depending on the storage network goals. All networks share the following features:

- One or two DX Cluster Services Nodes that provide services to the storage cluster.
- Two or more DX Storage Nodes that provide data storage services.
- Ethernet switches to enable required services within a storage cluster (private network) and access to the storage nodes from outside the cluster (public network).
- Services such as Domain Name System (DNS) and Dynamic Host Configuration Protocol (DHCP).



**NOTE:** DX Storage Cluster requires a dedicated internal network to ensure that the storage cluster traffic is protected from unauthorized access. The dedicated network also ensures that the external or corporate network is isolated from both the PXE boot server and cluster multicast traffic.

All network services required by the cluster are present in the DX Cluster Services Node software bundle and preinstalled on the Cluster Services Node. The DX Storage Cluster is automatically configured with defaults for all network parameters that should be sufficient for most simple configurations. All network parameters can be set manually to support more complex configurations. For detailed information about setting network parameters, see the *DX Object Storage Getting Started Guide* and the *DX Object Storage Advanced Administration Guide* at [support.dell.com/manuals](https://support.dell.com/manuals).

Network switch configuration depends on both the network topology and the customer environment. To ensure proper functioning with default network parameters and to maximize cluster performance, it is recommended that you follow the best practices listed below, while configuring both the private and public networks switches.

- Disable link aggregation configuration as the DX Object Storage Nodes bond the system NIC ports in balanced-alb modes.
- Disable jumbo frames.
- Disable spanning tree protocol, if the switches are not being trunked.
- Disable Flow Control.



**NOTE:** If switches are trunked, enable spanning tree protocol and port fast on the data intensive ports.

Contact Dell to customize the network configurations to meet the solution needs. For more information about configuring the network for the Dell DX Object Storage Platform, see "Network Topology" in the *DX Object Storage Advanced Administration Guide* at [support.dell.com/manuals](http://support.dell.com/manuals).

## Local Cluster Configuration

A basic Dell DX Storage Cluster consists of at least one DX Cluster Services Node and at least two DX Storage Nodes, along with the necessary Ethernet infrastructure to connect them. See Figure 2-1.

Within a cluster, DX Storage Nodes communicate with each other through User Datagram Protocol (UDP) and IP multicast. All nodes within a cluster must be on the same IP subnet. The DX Cluster Services Node also participates in UDP and multicast communication and must be located within the same subnet.

The Layer 3 switch (IP router) used to create the storage cluster subnet must:

- Restrict UDP and multicast network to the cluster subnet
- Pass TCP (HTTP) traffic to and from the DX Cluster Services Node and DX Storage Nodes



**NOTE:** You do not require a load-balancer in front of the storage cluster. The applications communicate directly with the DX Object Storage Platform through HTTP.

It is recommended that you configure the network topology to enable applications to communicate with the DX Storage Nodes on private and secure networks. This is the primary method to store and retrieve data from a local DX Storage Cluster.

**NOTE:** If applications write to a cluster through an unsecure network, then to prevent malicious activity, it is recommended that you allow the application to encrypt the data before writing the data to the cluster.

**Figure 2-1. Local Cluster Configuration**

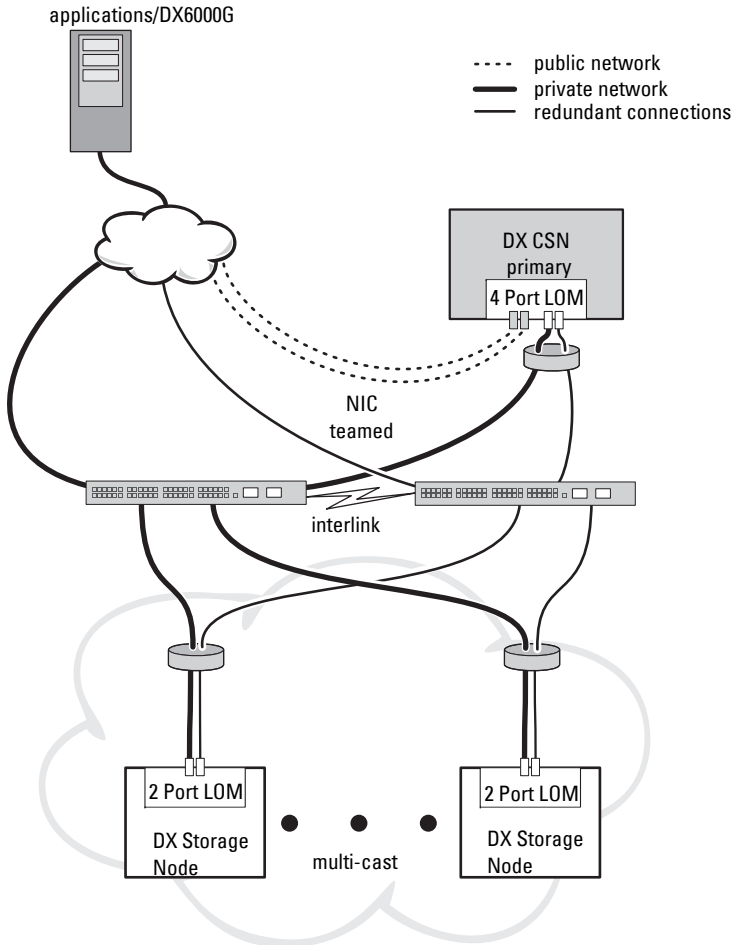

## Redundant DX Cluster Services Nodes

The Dell DX Storage Cluster supports redundant DX Cluster Services Nodes. In a redundant model, the active DX Cluster Services Node is configured as the primary node and the redundant node is configured as the secondary node. See Figure 2-2.

The primary Cluster Services Node contains the cluster configuration files, active networking utilities, and active content router services. A manual failover process is required to demote the primary DX Cluster Services Node and promote the secondary DX Cluster Services Node. Since there is a combined virtual IP address for the primary DX Cluster Services Node, a failover to a redundant DX Cluster Services Node is transparent to all applications. When a failover is transparent, an IP address change is not required. However, the application services remain unavailable until the manual failover of the Cluster Services Node is complete. For more information, see the *Cluster Services Installation and Configuration Guide* at [support.dell.com/manuals](http://support.dell.com/manuals).

**Figure 2-2. Redundant DX Cluster Services Nodes**

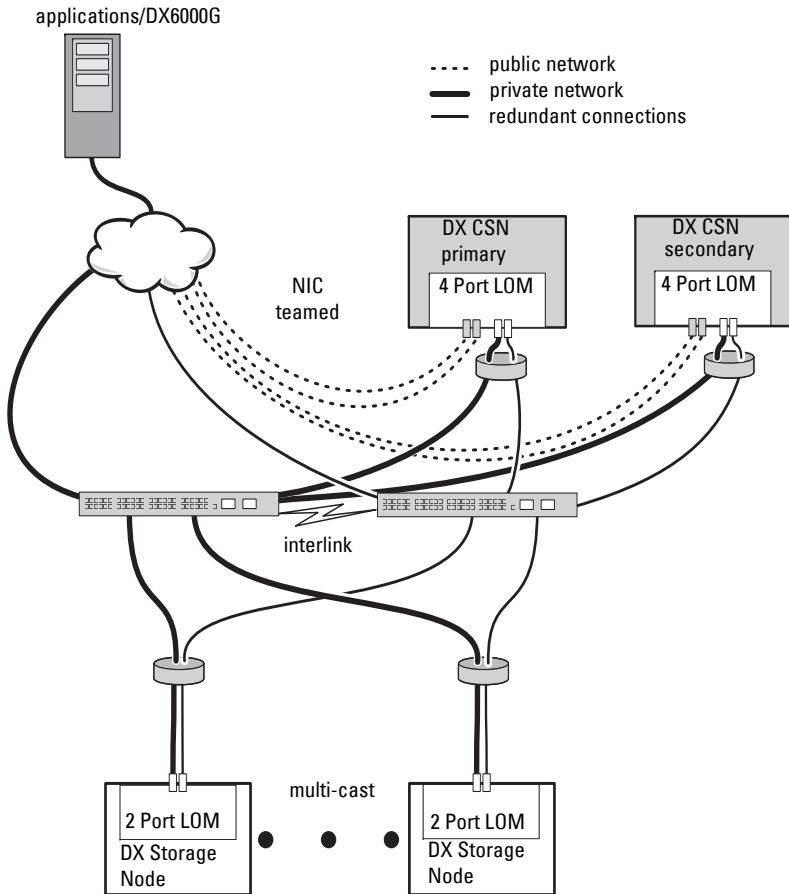

## Subcluster Configuration

A Dell DX Storage Cluster can be split into two or more subclusters. The subclusters are physically part of the same cluster but are recognized as logically separate entities by the DX Object Storage software that provides local area replication.

A subcluster can be:

- A set of nodes within one physical group (such as building, floor, wing, and so on)
- An environmental group (such as rack, network switch, and power circuit)
- Any other defined groups

If the building or power circuit fails, other nodes have an optimal set of data replicas. See Figure 2-3.

All DX Storage Nodes within the DX Storage Cluster have the same network connectivity requirements. The DX Storage Nodes must be in the same IP subnet, must be able to participate in multicast and UDP traffic, and so on. Clients may address DX Storage Nodes within any subcluster and are redirected to the proper DX Storage Node. As a result, application awareness of a subcluster configuration is not required.

For more information about subclusters, see "Local Area Replication" in the *DX Object Storage Advanced Administration Guide* at [support.dell.com/manuals](http://support.dell.com/manuals).

**Figure 2-3. Subcluster Configuration**

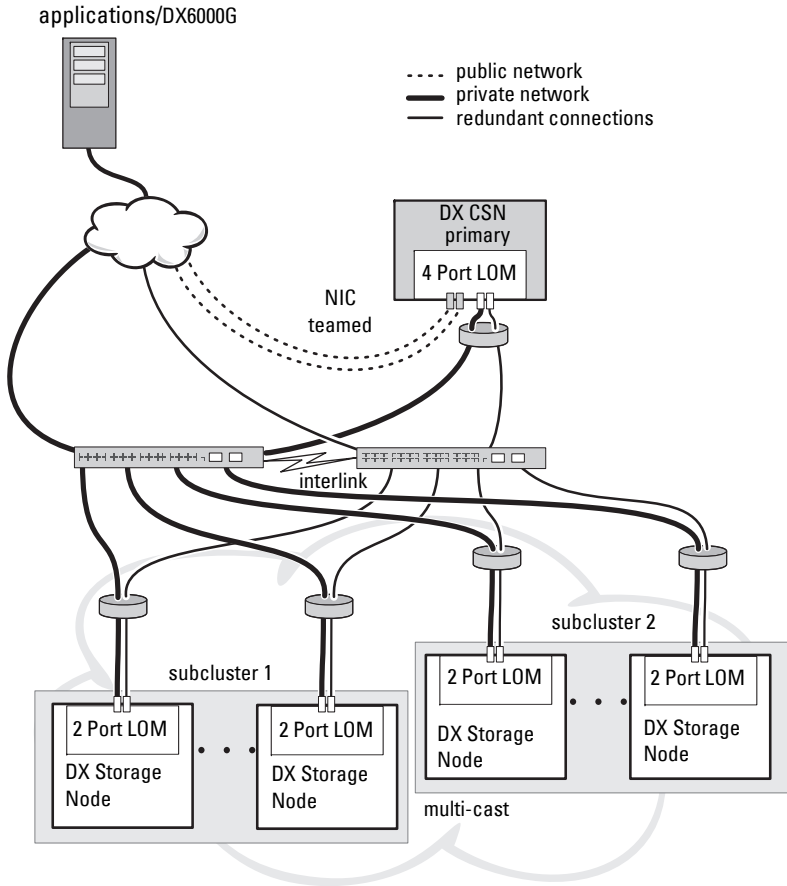

## Remote Cluster Configuration

When you deploy multiple DX Storage Clusters (for example multiple sites, offsite backup, and so on), the DX Cluster Services Node provides the ability to replicate data between DX Storage Clusters using the DX Content Router software.

The DX Content Router provides two services:

- Publisher service
- Replicator service

Clusters are connected by one cluster's replicator service to another cluster's publisher service. This link can either be one-way (for offsite backup) or two-way (for mirrored configurations).

Each publisher can support a number of replicators with a specific set of replication rules. The publisher does not provide same set of data objects to each replicator.

For redundancy, more than one DX Cluster Services Node may be present in a cluster, but only one DX Cluster Services Node can be active as a publisher at any time.



**NOTE:** There can be multiple publishers per cluster, but only the active (or primary) Cluster Services Node can be the active subscriber.

Clusters may be connected by any type of link that can handle the desired traffic volume. This link must be secured to prevent reading cluster data being passed between clusters. See Figure 2-4.

Cluster data is passed directly between the two DX Cluster Services Nodes. It is not recommended to have direct communication between storage nodes in remote clusters.

For more information about multiple cluster configurations, see the *Content Router Setup and Configuration Guide* at [support.dell.com/manuals](http://support.dell.com/manuals).



**Figure 2-4. Multiple Cluster Configuration**

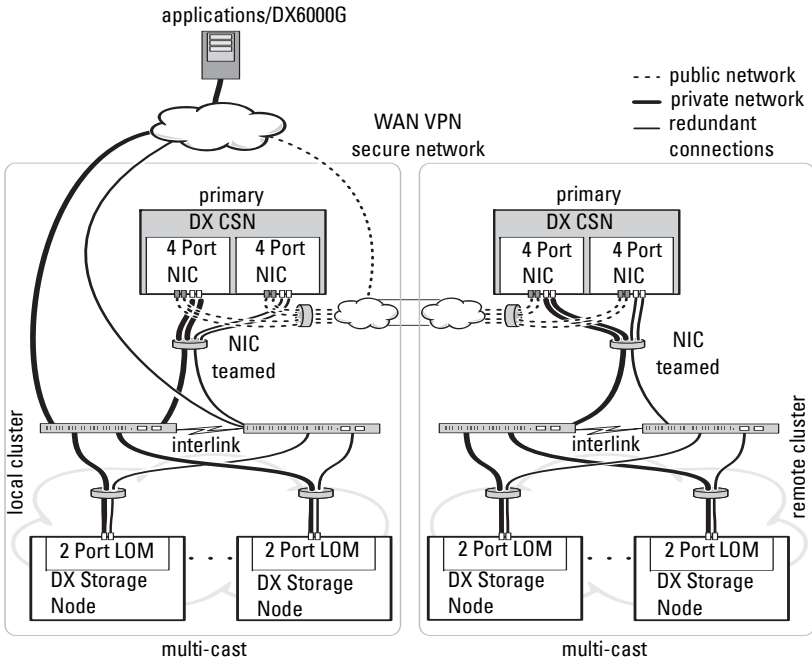

## **DX Cluster File Server Configuration**

When you deploy a DX Cluster File Server (CFS), the CFS must have direct access to the DX Storage Cluster on the private network and the public network. Gigabit Ethernet or higher is the recommended connection speed between the CFS server and the DX Storage Cluster Nodes.

The CFS contains six Ethernet ports. In a single server configuration, two Ethernet ports must be configured to the Public network and four to the DX Storage Cluster. In a failover configuration, it may be desirable to have a separate network dedicated to iSCSI traffic. You can configure two Ethernet ports to the Public Network, two to the iSCSI network, and two to the DX Storage Cluster. Depending on site requirements, these ports can be configured for link aggregation control protocol (LACP) operating in mode 4, or adaptive load balancing (ALB) operating in mode 6. Many sites prefer ALB as it does not require switch configuration. You may use any configuration that is commonly used in your environment.

A common network time protocol (NTP) time source is required for all CFS servers and the DX Storage Cluster to provide clock synchronization. If you use Active Directory, the NTP time source must be the same as the domain controller that is used for handling Active Directory based credentials.

## **Application Access to DX Object Storage Platform**

### **Communicating Directly With a Local Cluster**

Applications can communicate with a DX Storage Node at any time. The DX Object Storage software automatically redirects applications to the proper node even if the addressed node is an incorrect node to handle a request. If both Cluster Services Node and cluster nodes are not responding, you can communicate with the remote cluster by addressing the remote Cluster Storage Nodes or remote Cluster Services Node directly. For many configurations, it is recommended to create a single name through DNS which maps to the DX Storage Nodes. A single name allows communication with the DX Storage Nodes using one domain name. DNS automatically rotates addressing through the storage nodes. For more information, see the *DX Object Storage Application Guide* at [support.dell.com/manuals](http://support.dell.com/manuals).

## **Communicating Directly With a Remote Cluster**

Applications may communicate with a remote DX Storage Cluster during local-cluster disaster recovery. For an application to communicate to a remote DX Storage Cluster, the DX Cluster Services Node on the remote public network must be addressed. A proxy server on the DX Cluster Services Node (on the local cluster) accepts HTTP requests from the application and forwards them to a DX Storage Node in the DX Storage Cluster. The DX Storage Node redirects the requests if necessary, and returns the response back to the requester.

## **Communicating With a Cluster Through the Cluster File Server**

Applications that do not support HTTP integration with the DX Object Storage Platform can communicate with DX Storage through the DX Storage Cluster File Server (CFS). The CFS is an optional node in the DX Platform ecosystem that extends the DX Platform archiving front-end enablement to support a network file system for Windows and UNIX clients using CIFS and NFS protocols.



# Setting Up the DX Object Storage Platform

## Installing the Initial Cluster or Redundant Cluster Services Node

The Dell DX Object Storage Platform consists of at least one DX Cluster Services Node and two DX Storage Nodes. Installation of the initial cluster or additional Cluster Services Nodes require deployment services from Dell. For information about setting up the hardware, see:

- the *Getting Started Guide* for your Dell DX6a00 system at [support.dell.com/manuals](http://support.dell.com/manuals)
- the *Getting Started Guide* for the Dell DX6axyS system at [support.dell.com/manuals](http://support.dell.com/manuals)

## Configuring the DX Object Storage Platform

Dell DX Object Storage Platform includes a Cluster Services Node to enable a centralized management interface for the DX Cluster. Default settings are defined and recommended for system operation. However, there are a number of configuration options which may be used to configure the storage platform which are as follows:

- Reset administrator and operator passwords for the DX Cluster Services console
- Default object replication parameters
- Cluster name
- Port number for management console and other services
- IP parameters
- Logging options

- Simple Network Management Protocol (SNMP) options
- Setting persistent cluster settings
- Storing configuration files

For more information about these options, see the *Cluster Services Node Installation and Configuration Guide* at [support.dell.com/manuals](http://support.dell.com/manuals).

 **NOTE:** Use the Cluster Services Console for normal management and configuration. Only experienced administrators should use the configuration files for advanced configurations, described in the *DX Object Storage Advanced Administration Guide* and the *DX Object Storage Content Router Setup and Configuration Guide*. Contact your account team for professional services consulting on advanced configurations.

DX Content Router services are not automatically configured. To enable replication to remote clusters, publisher, and subscriber services, DX Content Router services must be configured through the DX Cluster Services console. For information about configuring DX Content Router services, see the *Cluster Services Installation and Configuration Guide* at [support.dell.com/manuals](http://support.dell.com/manuals).

For a complete list of reference documents, see "Additional References" on page 49.

## DX Content Router Rules Configurator

The DX Content Router Rules Configurator (CRRC) is a Java based application that helps you configure the rules used by the Publisher Service running on the DX Content Router. You can use this tool to generate the **rules.xml** file to enable compression. CRRC allows you to manage XML-based rule sets without requiring XML specific knowledge.

 **NOTE:** You can manually copy a **rules.xml** sample file from the **storage compression node** that is preconfigured for compression (Fast and Best channels, not cluster-level compression). For more information on configuring the DX Content Router manually instead of using the CRRC, see "Configuring DX Content Router" in the *DX Storage Compression Software Administrator's Guide* at [support.dell.com/manuals](http://support.dell.com/manuals).

## Using the Dell DX Content Router Rules Configurator

The CRRC runs on a DX Cluster Services Node (CSN) in a DX Storage cluster. It configures the `rules.xml` file located at `/etc/caringo/contentrouter/rules.xml`. For more information on the rule sets, see the *Content Router Setup and Configuration Guide* at [support.dell.com](http://support.dell.com).

To configure the DX content router rules using the CRRC:

- 1 Start the CRRC, by running the command at the installation path (`/opt/dell/crrc`):

```
./run_crrc.sh
```

The **Home** screen is displayed.

- 2 In the **Home** screen, select the type of rule set that you want the content router to use.



**NOTE:** By default, the **Fast** rule set is used by the content router.



**NOTE:** After you configure the cluster-level compressions using CRRC, configure the Compressor node. For more information, see "Appendix A.3" in the *DX Storage Compression Software Administrator's Guide* at [support.dell.com/manuals](http://support.dell.com/manuals).

- 3 You can select from a list of **Pre-defined rule sets**, create a **Custom rule set**, or **Modify current rule set** and click **Next**.

The **Editor** screen is displayed. You can view the **Main** tab and **XML** tab on the **Editor** screen. On the **Main** tab you can:

- Add Group
- Add Channel
- Add filter
- Delete
- Set OR condition
- Reset
- Modify existing filter node



**NOTE:** If you select **Modify current rule set**, proceed to step 4.

- 4 To modify an existing **Filter** node, select the relevant filter node. The **Filter editor** frame displays the selected filter node details.

- 5 In **Filter a stream by header or lifepoint?**, select **header** to filter the stream by its header, or select **lifepoint** to filter the stream by its lifepoint.
- 6 In **Select a filtering criterion**, select:
  - **Filter if header or lifepoint exists**
  - **Filter if header or lifepoint does not exist**
  - **Filter if header or lifepoint meets a criterion**
- 7 In **Select a type of header or lifepoint**, select the appropriate option for each header and lifepoint, or choose **Custom...** and in the **Enter custom value** field, enter the relevant value.
- 8 If you select, **Filter if header or lifepoint meets a criterion** in step 6, the **Insert Criterion** button in **Add Filtering criterion** is activated.
- 9 You can write a Boolean expression containing criteria. To generate the entered criteria click **Insert criterion**.

The **Add a Criterion** dialog box is displayed. It allows you to add a criteria based on the following filter types:

- **Filter based on date and duration of header or lifepoint**
  - **Filter based on value of header or lifepoint**
  - **Filter if header or lifepoint contains a string**
  - **Filter if header or lifepoint matches a string**
- 10 To add the selected criterion, click **Add**.

Or

To add the inverted logic of the selected criterion, click **Add inverted**.

For example, if you select to filter a stream that is older than date 01/01/2000 12:00:00 and click **Add Inverted**, the criterion will be added as `not olderThan ('Sat Jan 01 00:00:00 EST 2000')`, with 'not' in the beginning.

- 11 In the filter editor frame, click **Apply**, to apply the properties to the selected filter node.
- 12 In the **Editor** screen, click **Save**.



 **NOTE:** When you save the selected rule set, CRRC creates a backup file of the current **rules.xml** at **/etc/caringo/contentrouter/**. The backup file is named using a prefix of **rules** and the current date/time using the format **MMddyyyy\_HHmss** where **dd=day**, **MM=month**, **yyyy=year**, **HH=hour**, **mm=minute**, **ss=second** (for example, **rules\_10082011\_123356.xml**).

 **NOTE:** If you select **Modify current rule set** in the **Home** screen, the **Validate** button is displayed. To view the **Validation report**, click **Validate**. The validation report generates a report of any errors or warnings in the rule set in the **rules.xml** file. To save the validation report as a text file, click **Save as text**.

## Troubleshooting the Dell DX Content Router Rules Configurator (CRRC)

If problems are experienced with the CRRC application, verify the following:

- Ensure that the rpm is correctly installed. Run the `# rpm -q -a | grep crrc` command to determine the current version of the package name. The current version of the package must be 1.0.0.
- Ensure that the `JAVA_HOME` environment variable is set to the correct path by running the `echo $JAVA_HOME` command. The path needs to be set to the correct JRE or JDK installation directory (for example, `/opt/dell/crrc/jre1.6.0_25`). Do not use a forward slash at the end of the navigation path.
- If the user logs out of a Linux system, `JAVA_HOME` will be reset. Ensure that `JAVA_HOME` is set to the correct JRE or JDK installation directory after logging on (for example, `/opt/dell/crrc/jre1.6.0_25`).
- If the CRRC application is not starting, ensure that the:
  - `war-rules.dtd` exists at `/etc/caringo/contentrouter`.
  - `rules.xml` file content is properly formatted (for example, there are no missing tags).
- Restart the Content Router Publisher Service by running `/etc/init.d/cr-publisher restart` command.

If the problem persists, contact Dell.

## Adding Additional DX Storage Nodes

Before setting up the DX Storage Node, locate the *Getting Started Guide* shipped with your Dell DX6axyS system. Unpack and set up the DX platform hardware.

To set up the DX Storage Node hardware:

- 1 Rack and cable the DX6axyS system.
- 2 Turn on the DX6axyS system.
- 3 Enable capacity in the DX Cluster Services console.



**NOTE:** The DX Storage Node is preconfigured to network boot from the DX Cluster Services Node. The network ports must be connected to the private network before the system is turned on.

### Installing the System in a Rack

If the DX6axyS system includes a rail kit, locate the *Rack Installation Instructions* supplied with the rail kit. Follow the instructions to install the rails in the rack unit and to install the DX6axyS system in the rack.

### Cabling the Appliance

Locate the *Dell DX6axyS Getting Started Guide* that shipped with your system and follow the instructions to attach the power and network cables to the DX6axyS system. Connect the network ports to the cluster's private network on the same IP subnet as the other storage nodes. The DX Storage Node is preconfigured to network boot from the DX Cluster Services Node and the NIC ports are preconfigured in balanced-alb modes.

### Turning On the DX Storage Node

After cabling the storage node, turn it on, and verify that the network boot is successful.



**NOTE:** If the network boot is not successful, verify that the cables are correctly connected to the private network.

## Enabling Capacity in DX Cluster Services Console

The DX Storage Cluster capacity is licensed. To expand the cluster capacity, you must purchase a capacity license. On purchasing a capacity license, you receive a capacity license card that contains an activation code. Enter the activation code in the DX Cluster Services console to enable the additional cluster capacity.



**NOTE:** The capacity is only applicable to the cluster in which it is entered.

To activate additional cluster capacity, follow the instructions in the *Cluster Services Node Installation and Configuration Guide*.

## Adding Network Adapter to DX Storage Nodes

You can add additional network adapters to the DX Storage Nodes to expand the network bandwidth to the storage nodes. To add additional network adapters:

- 1 Turn off the DX Storage Node.
- 2 To add a network adapter, follow the steps in the Dell DX6axyS system *Hardware Owner's Manual*.
- 3 Connect the Ethernet ports to the private network. See Figure 3-5.
- 4 Turn on the DX Storage Node.

The DX Storage Node is automatically configured with all network ports bonded.

## Adding Network Adapters to DX Cluster Services Nodes

You can add additional network adapters to the DX Cluster Services Nodes to expand the network bandwidth on both the private and public network.



**NOTE:** Access to remote clusters is interrupted when the primary Cluster Services Node is offline. Do not promote a secondary Cluster Services Node to primary as it cannot be demoted back to secondary. Demoting the original primary Cluster Services Node as a secondary Cluster Services Node requires re-imaging the original primary Cluster Services Node.

To add additional network adapters:

- 1 Turn off the DX Cluster Services Node.
- 2 To add a network adapter, follow the steps in the Dell DX6a00 system *Hardware Owner's Manual*.

- 3 Connect the Ethernet cable(s) for the external and internal network accordingly. See Figure 3-5.
- 4 Turn on the DX Cluster Services Node.
- 5 Change the IP address of the external network interface to a new valid IP address from the **Content Services Configuration** page of the DX Cluster Services Administration console.

The first half of the Ethernet ports on the additional network adapter automatically bonds with the existing network ports on the external network and the second half automatically bonds with the existing network ports on the internal private network.

**NOTE:** The external network interface IP address can be set back to its original value. Modifying the external network IP address detects and bonds the additional network ports.

**Figure 3-5. Ethernet Cable Connections to the External and Internal Networks**

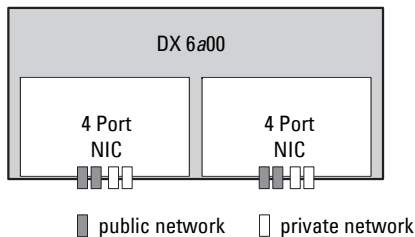

### Adding Cluster File Server Nodes

Installation of a DX CFS node requires deployment services from Dell. For information about setting up the hardware, see the *Hardware Owner's Manual* for your system at [support.dell.com/manuals](http://support.dell.com/manuals).

# Updating the Dell DX Object Storage Platform Software

Updates for the Dell DX Object Storage Platform software are periodically made available to correct problems, improve performance, introduce new capabilities, and support additional hardware. It is recommended that you download the updates to ensure that the cluster runs optimally. See the *Dell DX Object Storage Platform Interoperability Guide* at [support.dell.com/manuals](http://support.dell.com/manuals) to determine the minimum software versions supported.

DX Cluster Services Node updates may include:

- System BIOS
- System firmware
- System device drivers
- Operating system
- DX Cluster Services Node software
- DX Storage Node software

DX Storage Nodes updates may include:

- System BIOS
- System firmware



**NOTE:** DX Storage Node operating system and associated drivers are part of the storage node software image hosted on the DX Cluster Services Node. To update the storage node software across the cluster, see "Updating the DX Storage Node Software" on page 34.

DX Cluster File Server (CFS) updates may include:

- System BIOS
- System firmware
- System device drivers

- Operating system
- DX Cluster File Server software

## Checking Software Version Compatibility

The versions of the software and hardware components installed in the cluster are checked by the Dell DX Compatibility Manager which is installed on the DX Cluster Services Nodes. The Compatibility Manager collects information about the current BIOS, firmware, drivers, and software versions in your cluster. The Compatibility Manager compares these versions against a predetermined profile of a released version of DX Storage Platform components, identifies potential conflicts, and writes the status to a text file. It is recommended that you check the file after you make any change in the hardware or software within the cluster.

### Using the DX Object Storage Platform Compatibility Manager



**NOTE:** The primary Cluster Services Node checks the configuration of the storage nodes. The secondary Cluster Services Node only checks its own versions.

Each software and hardware component in the cluster displays a status level as described in Table 4-2.

**Table 4-2. Status Levels**

Status Level	Description
OK	The component is compatible
Warning	It is recommended to upgrade or downgrade the component
Critical	It is required to upgrade or downgrade the component
Error	An internal error occurred while checking the status
Disabled	The Compatibility Manager is disabled

To verify cluster compatibility:

- 1 Open the file `/opt/dell/dellACM/CMREPORT.TXT` on the primary Cluster Services Node.
- 2 Review the status information for the Cluster Services Node and the individual Storage Nodes.
- 3 For more detailed component status information, run the following command:

```
#/opt/dell/dellACM/dellacmscr.sh -report -host=  
<host name>
```

where `<host name>` is the name of the cluster services node or a storage node and can be obtained from the `CMREPORT.txt` file.

For more information on updating the Cluster Services Node and the Storage Node software, see "Updating the DX Cluster Services Node Software" on page 34 and "Updating the DX Storage Node Software" on page 34.

## Troubleshooting the Compatibility Manager

If you experience problems with Compatibility Manager, verify that the latest version is installed. Compatibility Manager can be downloaded from [support.dell.com](http://support.dell.com). Run the following commands to determine the current version of:

- The package name—`#rpm -q -a |grep dellacm`
- The package details—`#rpm -q -i <package name>`

If the problems persist, contact Dell.

## Updating the DX Cluster Services Node Software

Updates for the operating system, BIOS, firmware, device drivers, and the application software are available at [support.dell.com/support/downloads](https://support.dell.com/support/downloads).

 **NOTE:** Ensure that you provide the Service Tag or system model on the **Driver and Downloads** page before you search for system software updates.

You can update the system BIOS, firmware, operating system, and device drivers using:

- Dell Unified Server Configurator-LifeCycle Controller Enabled (USC-LCE)—USC-LCE uses iDRAC6 Express and/or Enterprise along with UEFI firmware to access and manage the hardware including component and subsystem management. It provides platform updates, hardware configuration, operating system deployment, and hardware diagnostics in a pre-operating system environment. For more information, see the *Dell LifeCycle Controller User's Guide* at [support.dell.com/manuals](https://support.dell.com/manuals).
- Dell Management Console (DMC)—DMC is the next generation one-to-many systems management application with enhanced discovery, inventory, monitoring, and reporting features. It is a web-based graphical user interface (GUI), which is installed on a management station in a networked environment. For more information, see the *Dell Management Console User's Guide* at [support.dell.com/manuals](https://support.dell.com/manuals).

## Updating the DX Storage Node Software

You can update system BIOS and firmware using:

- USC-LCE—This method requires a USB storage device with at least 5 GB of space.
- DMC—This method requires a DMC server present on the internal private network.

Storage node software updates are installed on the DX Cluster Services Node. The DX Storage Nodes are network booted from images residing on the cluster services node.



To update the software used in the storage cluster:

- 1 Install the new rpm using the following command:

```
rpm -ivh [new version]
```

A new DX Storage Node software version is displayed on the Cluster Services Node console after a successful installation of the storage node software on the DX Cluster Services Node.

- 2 To view the DX Storage Node software version, click **Cluster Services**→**Netboot Management**.
- 3 From the **Netboot Management** page, select the newly installed storage node software and reboot the DX Storage Cluster to apply the new software version.



**NOTE:** If concurrent data availability is a concern, you must reboot your cluster nodes one at a time. Suspend volume recovery from the DX Object Storage console or SNMP during the reboot process to prevent cluster churn.

## Receiving System Software Update Notifications

Dell technical update subscriptions allow you to receive critical product alerts, updates to files, drivers and utilities for your system.

To register for these notifications:

- 1 Go to [support.dell.com/support/downloads](https://support.dell.com/support/downloads).
- 2 Click on the **Technical Subscriptions** link under the **Drivers and Downloads** section.

## Updating OpenManage Server Administrator

To download updates for the OpenManage Server Administrator:

- 1 Go to [support.dell.com/support/downloads](https://support.dell.com/support/downloads).
- 2 Select **OpenManage Server Administrator Managed Node** under the **Systems Management** category.
- 3 Follow the installation instructions provided on the download page.

## Updating the DX Cluster File Server Software

Updates for the system operating system, BIOS, firmware, device drivers, and the application software are available at [support.dell.com/downloads](https://support.dell.com/downloads).



**NOTE:** Ensure that you provide the Service Tag or system model details on the **Driver and Downloads** page before you search for system software updates.

You can update the system BIOS, firmware, operating system, and device drivers using:

- Dell Unified Server Configurator—LifeCycle Controller Enabled (USC-LCE)—USC-LCE uses iDRAC6 Express and/or Enterprise along with UEFI firmware to access and manage the hardware, including component and subsystem management. It provides platform updates, hardware configuration, operating system deployment, and hardware diagnostics in a pre-operating system environment. For more information, see the *Dell LifeCycle Controller User's Guide* at [support.dell.com/manuals](https://support.dell.com/manuals).
- Dell Management Console (DMC)—DMC is the next-generation one-to-many systems management application with enhanced discovery, inventory, monitoring, and reporting features. It is a web-based graphical user interface (GUI) installed on a management station in a networked environment. For more information, see the *Dell Management Console User's Guide* at [support.dell.com/manuals](https://support.dell.com/manuals).

# Disaster Recovery

You can recover the Dell DX Cluster Services Node from a number of hardware or software failures.



**NOTE:** Contact Dell support if you need assistance on disaster recovery for the DX Cluster File Server.

Depending on the type of failure, you must:

- Recover the server disk
- Reinstall the operating system
- Reinstall the Cluster Services Node software
- Reinstall the DX Cluster File Server software
- Reinstall Dell OpenManage system management applications

## Recovery Solution Map

Keep the following guidelines in mind:

- Reinstallation of the operating system requires you to reinstall all the applications on the system.
- A non-recoverable failure of the disk group containing the operating system requires reinstallation of the operating system and all applications.
- For all non-disk related hardware failures, see the *Hardware Owner's Manual* for the relevant system at [support.dell.com/manuals](http://support.dell.com/manuals).

**Table 5-1. CSN System Recovery Map**

Failure Type	Potentially Affected System Components					Recovery Methods
	Hardware	Software				
	Server Disk Group	Operating System	Cluster Services Node Software	OpenManage Server Administration	DX Compatibility Manager	
Server RAID Group Failure (Disk Failure)	X	X	X	X	X	1,2,3,4,5
Operating System		X	X	X	X	2,3,4,5
Cluster Services Node			X			3
OpenManage Server Administrator				X		4
DX Compatibility Manager					X	5

1—"Recovering From Disk Failures" on page 39

2—"Reinstalling the Operating System" on page 40

3—"Reinstalling the DX Cluster Services Node Software" on page 43

4—"Installing Dell OpenManage Server Administrator" on page 46

5—"Installing Dell DX Compatibility Manager" on page 46

# Recovering From Disk Failures



**NOTE:** The DX Cluster Services Node system's internal disk storage is preconfigured as RAID 5.

## Single Disk Failure

The CSN is configured as RAID 5 to ensure uninterrupted operation of the system if a single disk fails. If a single disk failure occurs, replace the failed hard drive. For more information, see *Hardware Owner's Manual* for the affected system at [support.dell.com/manuals](http://support.dell.com/manuals). After the hard drive is replaced, it is automatically assigned by the RAID controller and rebuilt into the disk group. After the disk group is rebuilt, the RAID disk group continues to operate normally.



**CAUTION:** If a second drive fails before the disk group rebuild is complete, data loss occurs.

## Two Disk Failure

If the system experiences a two-disk failure, the RAID 5 group must be reconfigured and the operating system must be reinstalled. Follow the steps listed in Table 5-1 to recover from an operating system failure.

## Detecting and Monitoring Disk Failures

To optimize the protection of the RAID group on the system, it is essential that you detect hard drive failures immediately. Replacing failed disks immediately reduces the risk of unplanned downtime and loss of critical data. Ensure that you replace the failed disk with a new disk of the same capacity. If you use drives of greater capacity, some usable disk space is lost in the RAID 5 configuration.

You can use the following methods to monitor the health of the disks:

- Hard drive LED indicators—Monitors the drive activity and reports failures. For more information, see the system's *Hardware Owner's Manual* at [support.dell.com/manuals](http://support.dell.com/manuals).
- Dell OpenManage Server Administrator—Monitors the health of the internal disks.
- Dell Management Console—Centrally monitors the status of Dell systems. For more information about installing and using DMC, see the *Dell Management Console User's Guide* at [support.dell.com/manuals](http://support.dell.com/manuals).

## Reinstalling the Operating System

The operating system is preinstalled on the DX Cluster Services Node. After a multiple disk failure of the system's RAID group, reinstall the operating system:

- 1 Replace the failed hard drives.
- 2 Create a RAID 5 disk group across all hard drives of the DX Cluster Services Node.
- 3 Reinstall the operating system. For more information on replacing the hard drive, see "Recovering From Disk Failures" on page 39.



**NOTE:** If the RAID group has not failed and you are reinstalling the operating system, skip "Configuring and Managing RAID" on page 40.

## Configuring and Managing RAID

The BIOS Configuration Utility (<Ctrl><R>) is a storage management application embedded on the PERC H700 card that configures and maintains RAID disk groups and virtual disks. The BIOS Configuration Utility is independent of the operating system and is available during system startup. See the *Dell PowerEdge RAID Controller (PERC) H700 and H800 User's Guide* at [support.dell.com/manuals](http://support.dell.com/manuals) for more information about the BIOS Configuration Utility and virtual disk management.

Create a single RAID 5 group across all six internal drives. When creating the RAID group, configure two virtual disks.

- Set virtual disk 0 to 75 GB
- Set virtual disk 1 to size of the remaining capacity

## Recovering the Operating System

Use the Unified Server Configurator - LifeCycle Controller Enabled (USC-LCE) utility on the system to recover the operating system. For specific instructions, see "Deploying the Operating System using the OS Deployment Wizard" in the *Dell Unified Server Configurator - LifeCycle Enabled User Guide* at [support.dell.com/manuals](http://support.dell.com/manuals).

 **CAUTION: Reinstalling the operating system on existing disk drives erases all installed applications and data.**

Locate the operating system media that came with the system and proceed to the operating system deployment option from USC-LCE. Follow the instructions on the screen to install the operating system.

- When prompted to enter an installation number, select **Skip Entering Installation Number** option. The installation number can also be entered at a later stage.
- The DX Cluster Services Node software and DX Cluster File Server software installation processes require a YUM repository for updating package dependencies. Skip the installation number entry to save time during the dependency update process.
- To save time during the dependency update process, select **Do Not Connect** when prompted to connect to the Red Hat Network. You may connect to the Red Hat network once the DX Cluster Services Node software installation is complete.
- To configure the operating system partitions required for the CSN, see "Configuring the Partitions During Operating System Recovery" on page 41.

## Configuring the Partitions During Operating System Recovery

To configure the required partitions:

- 1 On the **Linux Partition Configuration** screen, select the **Review and Modify Partitioning Layout** option.
- 2 Click **Next**.
- 3 Click **New**.

- 4 In the **Allowable Drives** field, de-select the sdb volume.
- 5 Create a 10 GB restore partition of the file system type physical volume (LVM) within the sda and click **OK**.
- 6 Select `/dev/sdb1` from the **Device** list and click **Edit**.
- 7 Select **Format partition** as `ext3`.
- 8 In the **Mount Point** field, enter `/u01` and click **OK**.  
The `/u01` mount point occupies the entire space of the sdb.
- 9 Click **Next**.

The `/u01` mount path can also be configured after installing the operating system.

To configure the mount path after installing the operating system:

- 1 Identify the disk to be formatted. To identify the disk to be formatted, run the following command:

```
fdisk -l | grep '^Disk'
```

- 2 Create a partition on the `/dev/sdb` block device using *parted*:  
`parted /dev/sdb`

- 3 Create a gpt label on the block device:

```
(parted) mklabel
```

```
Yes/No: Yes
```

```
New disk label type? [gpt]? gpt
```

- 4 Create a partition that consumes the entire available space on `/dev/sdb`:  
`(parted) mkpart primary ext3 0 -1`

Once the partition is created, exit using the following command:

```
(parted) quit
```

- 5 Create a file system on the formatted partition table. For example, run the following command:

```
mkfs.ext3 -m1 /dev/sdb1
```



- 6 Create the /u01 directory in root directory and mount the file system to the /u01 directory. For example, run the following command:

```
mkdir /u01
mount /dev/sdb1 /u01
```

- 7 To keep the mount path persistent across reboot, add the mount path to /etc/fstab. For example, run the following command:

```
vi /etc/fstab
```

Table 5-2 lists the options that must be selected to create a mount path.

**Table 5-2. Options to Create a Mount Path**

#	device name	Mount Path	fs type	options	dump-freq	pass-num
	/dev/sdb1	/u01	ext3	defaults	1	2

## Reinstalling the DX Cluster Services Node Software

### Setting Up and Configuring the Network

The DX Cluster Services Node software requires access to both the external network and to a dedicated internal network. The internal private network ensures that the DX Storage Cluster traffic is protected from unauthorized access and that the external network is isolated from both the PXE boot server and cluster multicast traffic. The DX Cluster Services Node software automatically allocates the first half of the Ethernet ports detected on each NIC interface card to the external network and the second half of the Ethernet ports detected on each NIC interface card to the internal network. All NICs allocated to a network are bonded into a bond interface using mode 6 or balance alb bonding. For example, on a server with four LOM ports and a quad port NIC adapter, LOM ports 0-1 and NIC adapter ports 0-1 are allocated to the external network in a balance-alb bond interface and LOM ports 2-3 and NIC adapter ports 2-3 are allocated to the internal network in a balance-alb bond interface.

 **NOTE:** Network switch configuration is outside the scope of the DX Cluster Services Node software. Switches must be properly configured by a system administrator to ensure correct connectivity and bonding mode support. Administrators must not connect the configured internal network ports to the external network.

## Connecting the DX Cluster Services Node to the Private and Public Networks

- Connect the lower NIC ports 0-1 of the DX Cluster Services Node to the external private network switch.
- Connect the upper NIC ports 2-3 of the DX Cluster Services Node to the internal network switch.

## Connecting the DX Storage Nodes to the Private Network

Connect all the NIC ports (LOM as well as add on card, if available) of each storage node to the internal private network switch.

 **NOTE:** Do not turn on the storage nodes at this time.

## Creating a Local YUM Repository on the DX6000 System

The DX Cluster Services Node software installation process is dependent on additional rpm packages that are not installed on the systems by default. These packages are available on the Red Hat Enterprise Linux distribution media included with the system. A local YUM repository is required to update the system with the package dependencies for the DX Cluster Services Node software installation.

To create a local YUM repository on your system:

- 1 Turn on the DX Cluster Services Node.
- 2 Insert the operating system media that came with the system into the optical drive and allow the file system to auto mount. The default directory path for the auto mounted file system is `/media/RHELx.x`

x86\_64\ DVD. The white spaces in this file path causes errors during the YUM setup process. If the drive auto mounts, run the following commands:

```
# mkdir /media/dvd
# mount --move /media/RHEL_x.x\ x86_64\ DVD
/media/dvd
```

If the CDROM does not auto mount, perform the following commands.

```
# mkdir /media/dvd
# mount /dev/dvd /media/dvd
```

 **NOTE:** For more information on the compatible RHEL versions, see the *Dell DX Object Storage Platform Interoperability Guide* at [support.dell.com/manuals](http://support.dell.com/manuals).

- 3 Define the repository where your copy of rpm packages are stored. To define the repository, create a new file in `/etc/yum.repos.d` named `rhel-dvd.repo` using the following commands:

```
# cd /etc/yum.repos.d
# cp rhel-debuginfo.repo rhel-dvd.repo
# vi rhel-dvd.repo
```

- 4 Change the following lines in `rhel-dvd.repo` file:

```
[base]

name=Red Hat Enterprise Linux $releasever -
$basearch - Base

baseurl=file:///media/dvd/Server
pgpcheck=1
enabled=1
pgpkey=file:///etc/pki/rpm-gpg/RPM-GPG-KEY-
redhat-release
```

- 5 Remove any cached packages from the system and enable the local YUM repository:

```
# yum clean all
# yum repolist
```

The system is now ready to be updated with all the dependencies required to install the DX Cluster Services Node software or the DX Cluster File server software.

## Installing Dell DX Compatibility Manager

The Dell DX Compatibility Manager is available as an rpm package. To install the DX Compatibility Manager:

- 1 Download the latest version of rpm package from [support.dell.com](http://support.dell.com).
- 2 Copy the rpm package to a directory on your system.
- 3 Install the rpm package using the following command:

```
# rpm -i <package>.rpm
```

## Installing Dell DX Content Router Rules Configurator

The Dell DX Content Router Rules Configurator (CRRC) application is available as an rpm package. To install the CRRC:

- 1 Download the latest version of rpm package from [support.dell.com](http://support.dell.com).
- 2 Copy the rpm package to a directory on your system.
- 3 To install the rpm package run the following command:

```
rpm -ivh <package>.rpm
```

The CRRC application components are copied to `/opt/dell/crrc/`.

- 4 To install CRRC, run the following command:
- 5 To start CRRC run the following command:

```
source crrc_install.sh
```

```
./run_crrc.sh
```

- 6 The CRRC application should launch.

## Installing Dell OpenManage Server Administrator

Dell Server Administrator provides a comprehensive, one-to-one systems management solution from:

- An integrated, web browser-based graphical user interface (GUI)
- A command line interface (CLI) through the operating system

The Server Administrator is designed for system administrators to manage systems locally and remotely on a network. It allows system administrators to focus on managing their entire network by providing comprehensive one-to-one systems management.

You can install Server Administrator using the *Dell Systems Management Tools and Documentation* media. The media provides a setup program to install, upgrade, and uninstall the Server Administrator, managed system and management station software components. Additionally, you can install the Server Administrator on multiple systems through an unattended installation across a network.

The Dell OpenManage installer provides installation scripts and RPM packages to install and uninstall the Server Administrator and other managed system software components on your managed system. For more information, see the *Dell OpenManage Server Administrator Installation Guide* and the *Dell OpenManage Management Station Software Installation Guide* at [support.dell.com/manuals](http://support.dell.com/manuals).

## Installing DX Cluster Services Node Software

If you have at least one data replica, any data on the failed storage node or hard drive is replicated to another storage node in the cluster. Hardware status for the DX Storage Nodes can be monitored from the **DX Object Storage Node Administration Console**. Replace any failed hardware components on the DX Storage Nodes as required to bring the failed node back into service.

The DX Cluster Services Node software distribution is available as a collection of rpm packages that are installed with a self-extracting shell script. The packages and their dependencies must be installed on the DX6a00 system as the root user.

To install DX Cluster Services Node software:

- 1 Download the latest version of the DX Cluster Services Node software distribution available online at [support.dell.com/downloads](http://support.dell.com/downloads).
- 2 Copy the distributed zip file to your DX Cluster Services Node system and unzip it into the directory of your choice.

- 3 Install the DX Cluster Services Node software by running the self-extracting script from inside the bundle directory location where the shell script was unzipped.

This initiates installation of the DX Cluster Services Node software and its dependent packages. For more information, see the *Cluster Services Node Installation and Configuration Guide* at [support.dell.com/manuals](http://support.dell.com/manuals).

- 4 Eject the operating system media from the optical drive using the following command:

```
# eject /media/dvd
```

- 5 Reboot the DX6a00 system when the installation completes.

Use the following command to reboot the system:

```
# reboot
```

## Configuring the DX Cluster Services Node Software

After installing and rebooting the DX Cluster Services Node, you are automatically prompted to enter some minimal configuration data to configure and deploy the DX Cluster Services Node. This configuration process is required only once after the initial installation. Any necessary updates to the parameters entered during this initial boot process can be made from the Cluster Services Node Console. For more information about configuring the Cluster Services node, see the *Cluster Services Node Installation and Configuration Guide* at [support.dell.com/manuals](http://support.dell.com/manuals).

## Restoring the Cluster Configurations

Previous cluster configuration files can be restored through the Cluster Services Node Console (Cluster Services TAB Backup and Restore). For more information on restoring cluster configurations, see the *Cluster Services Node Installation and Configuration Guide* at [support.dell.com/manuals](http://support.dell.com/manuals).

## Bringing Up the DX Storage Cluster

Turn on the storage nodes in your cluster. Each storage node network boots from a DX Storage Node image located on the DX Cluster Services Node.

# Additional References

## Software Documents

**Table 6-1. Software Documents**

<b>Document</b>	<b>Description</b>	<b>Location</b>
<i>DX Storage Compression Node Deployment Guide</i>	Covers the steps required to configure a Storage Compression Node.	<a href="http://support.dell.com/manuals">support.dell.com/manuals</a>
<i>Dell DX Object Storage Platform User's Guide</i>	Provides an overview of the DX Object Storage Platform and steps to upgrade and recover the platform.	<a href="http://support.dell.com/manuals">support.dell.com/manuals</a>
<i>Cluster Services Node Installation and Configuration Guide</i>	Provides information on configuration and administration tasks for deploying and monitoring a DX Cluster Services Node.	<a href="http://support.dell.com/manuals">support.dell.com/manuals</a>
<i>DX Object Storage Getting Started Guide</i>	Covers the basic steps necessary to deploy and administer a DX Storage Cluster.	<a href="http://support.dell.com/manuals">support.dell.com/manuals</a>
<i>DX CFS Setup and Configuration Guide</i>	Provides information on configuration and administration tasks to deploy and monitor a DX Cluster File Server.	<a href="http://support.dell.com/manuals">support.dell.com/manuals</a>
<i>DX Object Storage Advanced Administration Guide</i>	Covers advanced configuration and administration tasks for deploying and monitoring a DX Storage Cluster.	<a href="http://support.dell.com/manuals">support.dell.com/manuals</a>

**Table 6-1. Software Documents (continued)**

<b>Document</b>	<b>Description</b>	<b>Location</b>
<i>DX Object Storage Application Guide</i>	Guides application programmers who are developing or customizing client-side programs.	<a href="http://support.dell.com/manuals">support.dell.com/manuals</a>
<i>Content Router Setup and Configuration Guide</i>	Covers the steps required to configure Content Router and the administration actions necessary to monitor and run one or more Content Router nodes.	<a href="http://support.dell.com/manuals">support.dell.com/manuals</a>
<i>SCSP Proxy Overview</i>	Provides an overview of the SCSP proxy and covers the steps for configuring and running the proxy.	<a href="http://support.dell.com/manuals">support.dell.com/manuals</a>
<i>Dell DX Object Storage Platform Interoperability Guide</i>	Provides details of supported platforms, peripherals, and software.	<a href="http://support.dell.com/manuals">support.dell.com/manuals</a>
<i>Cluster Services Node Release Notes</i>	Contains late-breaking information about your appliance.	<a href="http://support.dell.com/manuals">support.dell.com/manuals</a>
<i>DX Object Storage Release Notes</i>		
<i>Content Router Release Notes</i>		



# Hardware Documents

**Table 6-2. Hardware Documents**

<b>Document</b>	<b>Description</b>	<b>Location</b>
<i>Dell DX6000 Getting Started With Your System</i>	Helps you get started with the Dell DX6000 systems.	<a href="http://support.dell.com/manuals">support.dell.com/manuals</a>
<i>Dell DX6000 Hardware Owner's Manual</i>	Contains information specific to your Dell hardware.	<a href="http://support.dell.com/manuals">support.dell.com/manuals</a>
<i>Dell DX6012S Getting Started With Your System</i>	Helps you get started with the Dell DX6012S systems.	<a href="http://support.dell.com/manuals">support.dell.com/manuals</a>
<i>Dell DX6000G Getting Started With Your System</i>	Helps you get started with the Dell DX6000G systems.	<a href="http://support.dell.com/manuals">support.dell.com/manuals</a>
<i>Dell DX6012S Hardware Owner's Manual</i>	Contains information specific to your Dell hardware.	<a href="http://support.dell.com/manuals">support.dell.com/manuals</a>
<i>Dell DX6004S Getting Started With Your System</i>	Contains information specific to your Dell hardware.	<a href="http://support.dell.com/manuals">support.dell.com/manuals</a>
<i>Dell DX6000G Hardware Owner's Manual</i>	Contains information specific to your Dell hardware	<a href="http://support.dell.com/manuals">support.dell.com/manuals</a>
<i>Dell DX6004S Hardware Owner's Manual</i>	Contains information specific to your Dell hardware.	<a href="http://support.dell.com/manuals">support.dell.com/manuals</a>
<i>Rack Installation Guide</i>	Contains information on installing the system in a rack.	<a href="http://support.dell.com/manuals">support.dell.com/manuals</a>
<i>Dell PowerEdge RAID Controller (PERC) H200 and 6 Gbps SAS HBA User's Guide</i>	Contains information on the Serial Attached SCSI H200 adapter.	<a href="http://support.dell.com/manuals">support.dell.com/manuals</a>
<i>Dell PowerEdge RAID Controller (PERC) H700 and H800 User's Guide</i>	Contains information on the Serial Attached SCSI H700 adapter.	<a href="http://support.dell.com/manuals">support.dell.com/manuals</a>

**Table 6-2. Hardware Documents (continued)**

<b>Document</b>	<b>Description</b>	<b>Location</b>
<i>Dell DX Support Matrix</i>	Compatibility Matrix for the DX Object Storage Platform.	<a href="http://support.dell.com/manuals">support.dell.com/manuals</a>

## Systems Management Documents

**Table 6-3. Systems Management Documents**

<b>Document</b>	<b>Description</b>	<b>Location</b>
<i>Dell OpenManage Software Installation and Security User's Guide</i>	Describes how to install Dell OpenManage Server Administrator software.	<a href="http://support.dell.com/manuals">support.dell.com/manuals</a>
<i>Dell OpenManage Server Administrator User's Guide</i>	Describes how to use Dell OpenManage Server Administrator to manage your system.	<a href="http://support.dell.com/manuals">support.dell.com/manuals</a>
<i>Dell Management Console User's Guide</i>	Describes how to use Dell Management console to manage your systems.	<a href="http://support.dell.com/manuals">support.dell.com/manuals</a>